

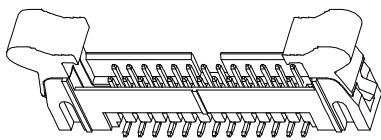

SPECIFICATIONS

- Current Rating: 2Amp
- Contact Resistance: 20mΩ Max
- Withstand Voltage: 500V AC/DC
- Insulation Resistance: 1000MΩ Min
- Operation Temperature: -40°C~105°C
- Contact Material: Brass
- Contact Plating: Au or Sn over Ni
- Insulation Material: PA9T+30GF(UL94V-0)

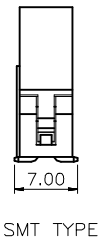
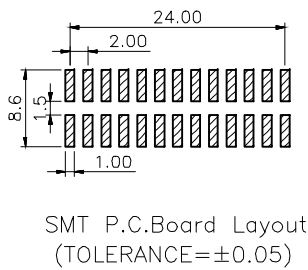
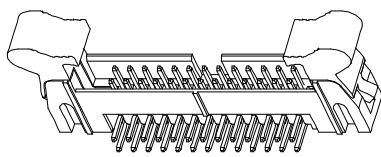
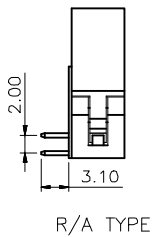
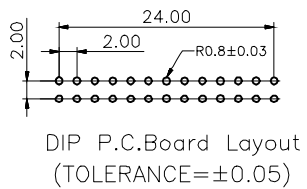
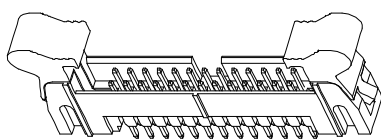
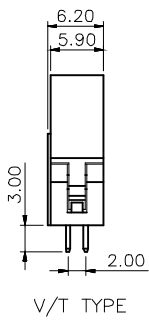
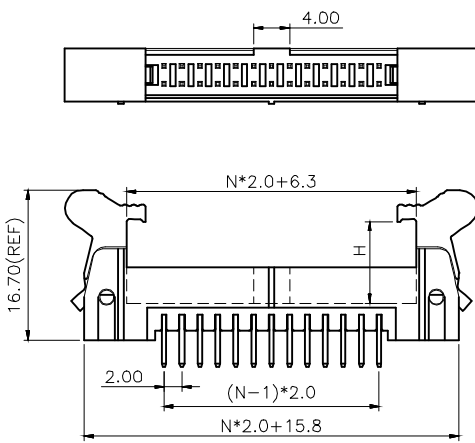

Any size and shape can be customized.
Contact sales team for more information.

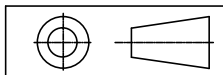

PRODUCT NAME 2.0MM EJECTOR HEADER SERIES	DIM	TOL	DWG NO.	DRAW	Wu	PART NO	CUST
	X.X	±0.4	P.W	CHECK	Tomy	UNIT	DATE
	X.XX	±0.25	MATER	APPR	Allan	MM[INCH]	XXXX.XX.XX
	ANGLE	±3°	REV.			东莞市同盈电子有限公司 DONGGUAN WIN-WIN ELECTRONIC Co., Ltd.	